

RoHS Compliant

Rev.	ECO#	Date	By
C	1461-0921	09/21/21	MWP

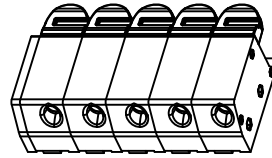
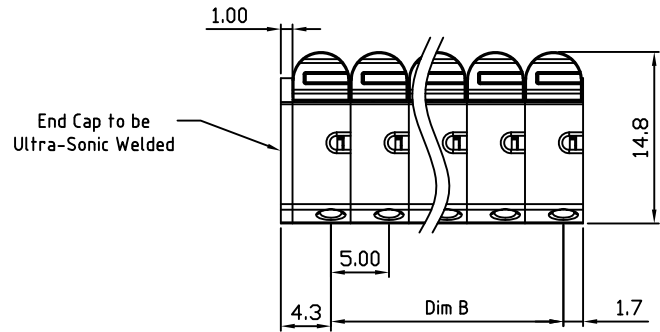

Rounded Button

Material:	
Contact:	Brass, Tin Plated
Wire Retention Spring:	Stainless Steel
Insulating Body:	PA6T, 20% GF, UL94V-0
Push Button:	PA6T, 20% GF, UL94V-0
Electrical	
Voltage Rating:	300 VAC
Current rating:	7 AMPS
Wire Range:	16-24 AWG
Mechanical	
Operating Temperature:	-40°C to +115°C -40°F to +239°F

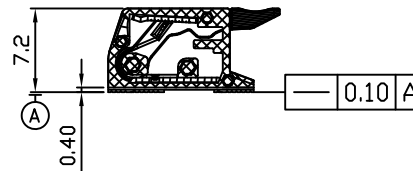
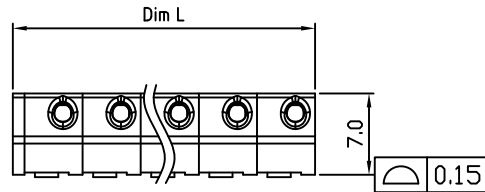
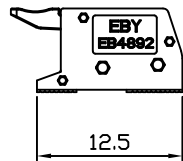

Dim.L=P×5.0+1.0		
Dim.B=(P-1)×5.0		
P= number of poles(2-12p)		
	Dim B	Dim L
0-30mm	±0.15	±0.20
over 30mm-60mm	±0.20	±0.25
over 60mm-90mm	±0.25	±0.30
over 90mm	±0.30	±0.40

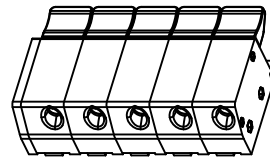
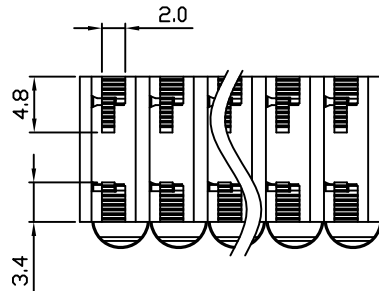

Straight Button

Part Number Configuration.

EB4892-XX-0XX

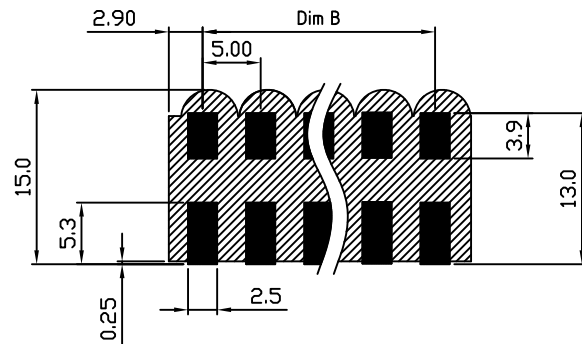
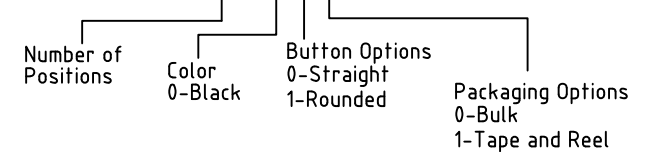

PCB LAYOUT

Max Number of Positions = 24

UNLESS OTHERWISE SPECIFIED BREAK ALL SHARP EDGES AND DEBURR ALL HOLES
 TITLE: 5.00mm SPACING, MODULAR, PLUGGABLE

LIMITS: UNLESS OTHERWISE SPECIFIED HUND. ±0.2 FRACT. ±1/64 THOU. ±0.05 ANGLE ±1°	SCALE	THIS IS A CONFIDENTIAL DRAWING AND MUST BE TREATED AS SUCH. NO DISTRIBUTION IS ALLOWED WITHOUT WRITTEN APPROVAL BY EB4892 INC.	Electro Inc. PLAINVIEW, NY 11803
---	-------	--	-------------------------------------

IMPORTANT DISCLAIMER: All information provided on this print is for reference. Always perform your own tests and acquire samples and further information to determine product suitability. While we make effort to provide accurate information, we cannot be responsible for errors either of omission or typographical. EB4892 Electro, Inc. assumes no responsibility for the use or suitability of any product. All products and specifications are subject to change without prior written notice.

METRIC LIMITS ONE PLACE ±0.3 TWO PLACES ±0.10 ANGLE ±1°	DRAWN MWP CHECKED _____ APPROVED _____	DATE 01/25/19 DATE _____ DATE _____	SIZE A	DRAWING NUMBER: EB4892-XX-0XX	REV. C
--	--	---	--------	----------------------------------	-----------